

## CONVIVIO 1400

Kitchen Sinks

Code: N050 S50

EVIER CONVIVIO 1400 SOUS-PLAN INOX



### DETAILS

Finish Foster brushed

---

Material AISI 304 stainless steel

---

Texture Brushed in line

---

Edge/Installation Type Undermount

---

Dimensions 1447x502 mm

---

Standard fittings Fixing hooks, gasket, drain, overflow and siphon, boxed packing

---

Mixer holes No standard holes

---

Built-in hole 1397x477 mm

---

Drainer No

---

Width	145 cm
Bowl dimension	1397x400 mm
Number of bowls	1 bowl
Waste fitting	Drain SPACE 3,5"

## EQUIPMENT

1 x Black Grid 8100 600  
1 x Bamboo chopping board  
8200 002

## FEATURES

Diamond-shape bottom	The draining of water is an important feature in a sink, and it's always taken good care of in Foster products. In the bent-welded sinks, which would have a flat bottom, the proper draining is guaranteed by the elegant beveling, which helps the water flow.
High thickness	1mm thick steel. A significant thickness, which guarantees the maximum sturdiness and durability.
Space waste fitting	The elegant SPACE steel cap closes the drain and leaves no visible residues collected in the basket below. Space also has a small footprint and allows the optimal use of the under-sink compartment.
Save space system	Drain and siphon are designed to leave as much space as possible in the under-sink area, more and more useful today for theseparate waste collection systems.
Triple recess - sliding accessories	The Foster Milano sink has an ingenious design that makes it simple to use a large set of optional accessories. On the topmost supporting step, the innovative Black grids slide, creating a large and practical surface to rinse food and crockery. The second step is meant to support and allow the sliding of a complete combination of accessories, which make some operations practical and safe: rinse, drain, slice, grate... everything can be done inside the sink. The third supporting step is on the bottom of the bowl. On this step one can rest the Black grids, making it possible to rinse foodstuffs without their coming in contact with the bottom of the sink, which may be dirty.

## Perimetral overflow

The overflow is always a security on the Foster sinks that prevents the overflow of water in case of oversights. The perimeter drain solution improves aesthetics thanks to its square and essential shape.

## TECHNICAL DATA

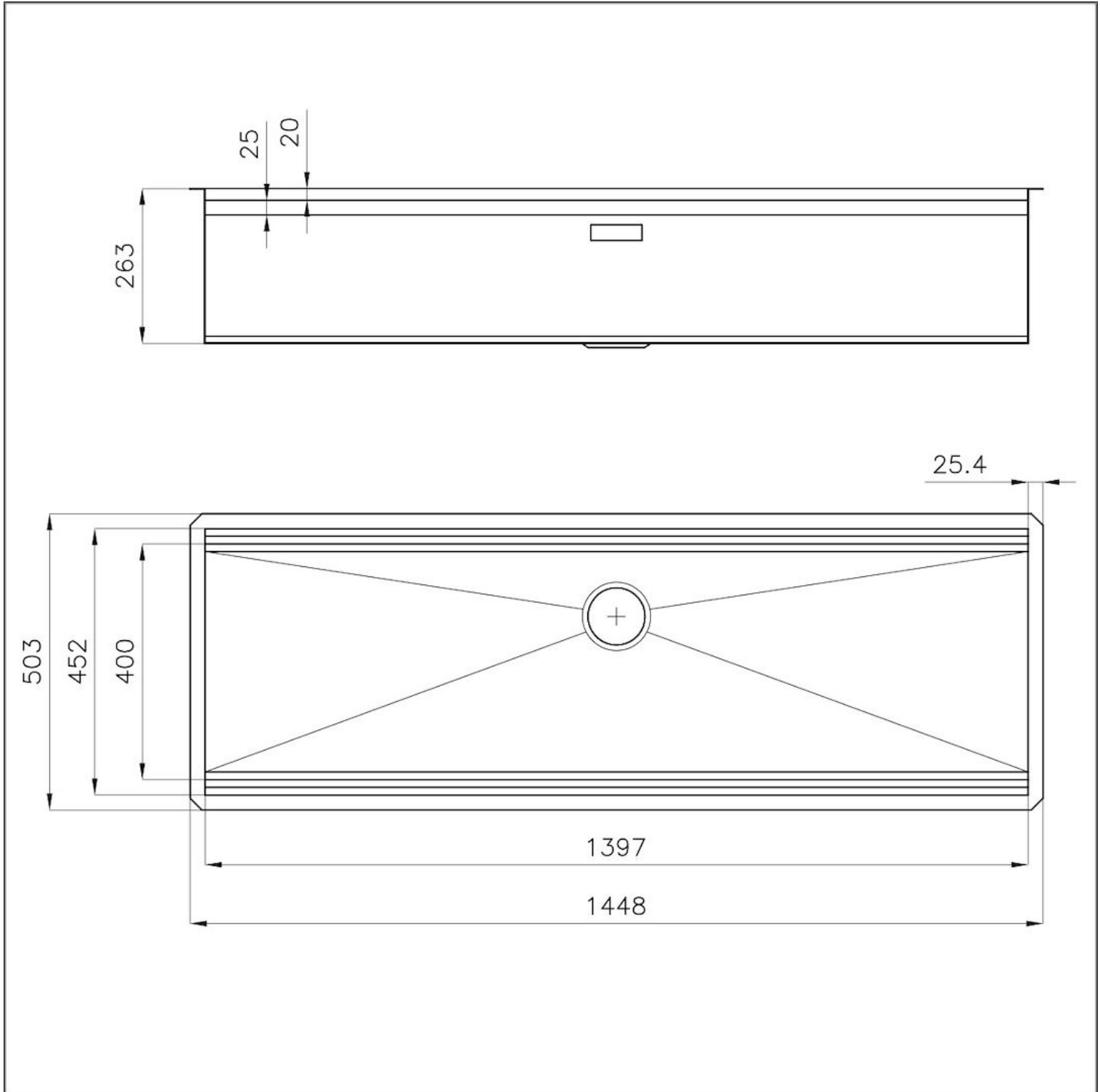

## Happy Hour Optional accessories / Accessori opzionali

The "rails" system makes it possible to use a combination of numerous accessories. Grids, chopping boards, utensils' ranging system, bowls and containers of different dimensions can be alternated in the workspace with a simple gesture, and can easily be stacked, in order to be on hand at all times.

Il sistema di "corsie" rende possibile l'utilizzo combinato di innumerevoli accessori. Griglie, taglieri, portautensili, vaschette e contenitori di varie dimensioni si alternano nella zona di lavoro con un semplice gesto e possono essere impilati, sempre a portata di mano.

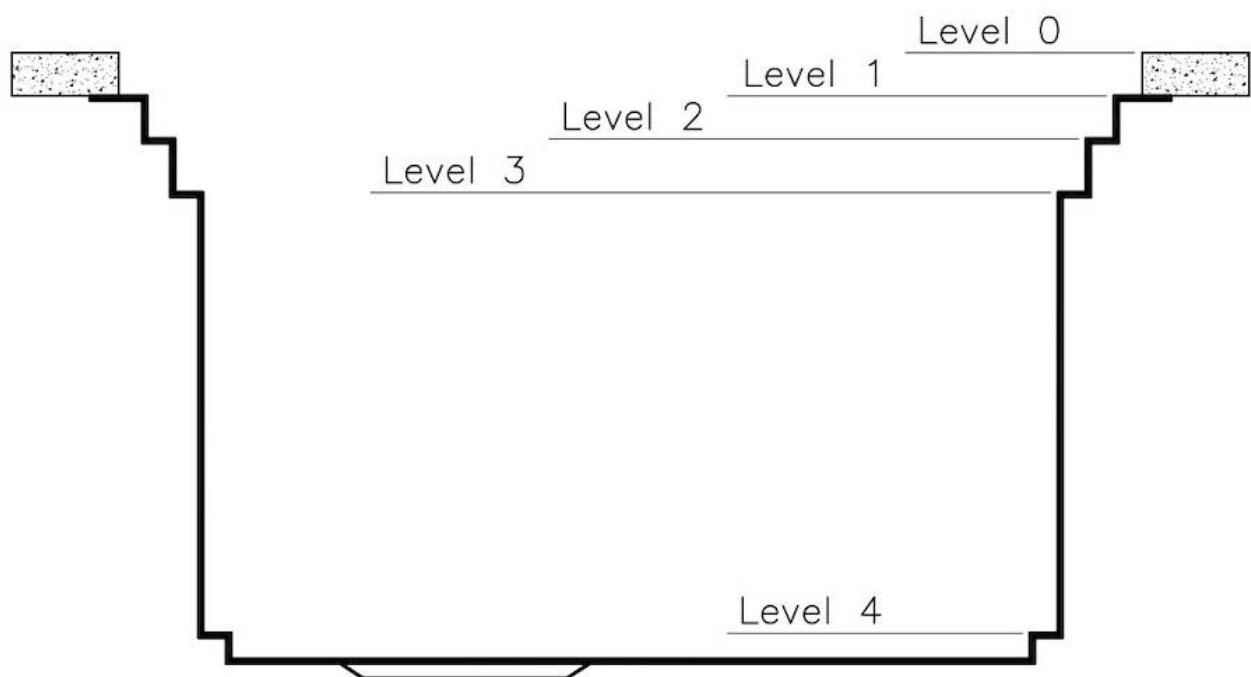

## Happy Hour Level 0

Compatible accessories/Accessori compatibili:

8200 002

8200 601



## Happy Hour Level 1

Compatible accessories/Accessori compatibili:

8100 625

8100 626

8100 627



## Happy Hour Level 2

Compatible accessories/Accessori compatibili:

8100 600  
8100 620  
8100 621  
8100 622  
8100 628  
8624 000

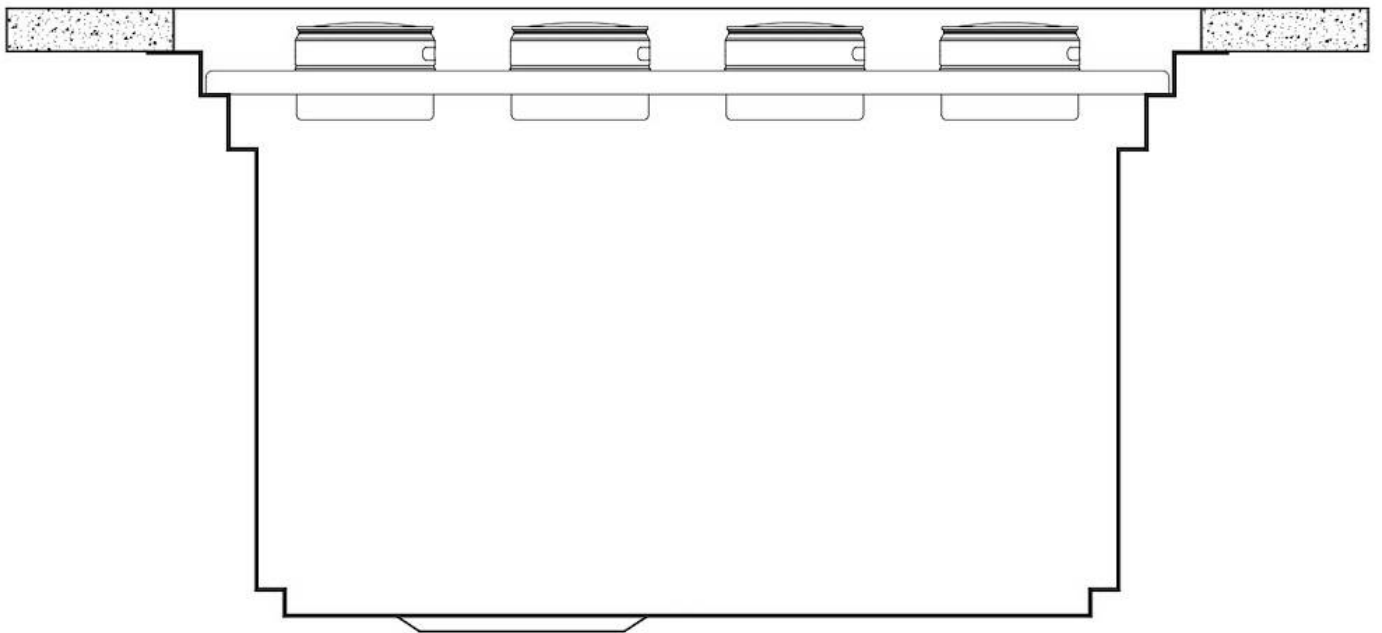

## Happy Hour Level 3

Compatible accessories/Accessori compatibili:

8644	101
8153	100
8631	300
8200	002
8200	601
8100	623
8100	624





## Happy Hour Level 4

Compatible accessories/Accessori compatibili:

8100 600



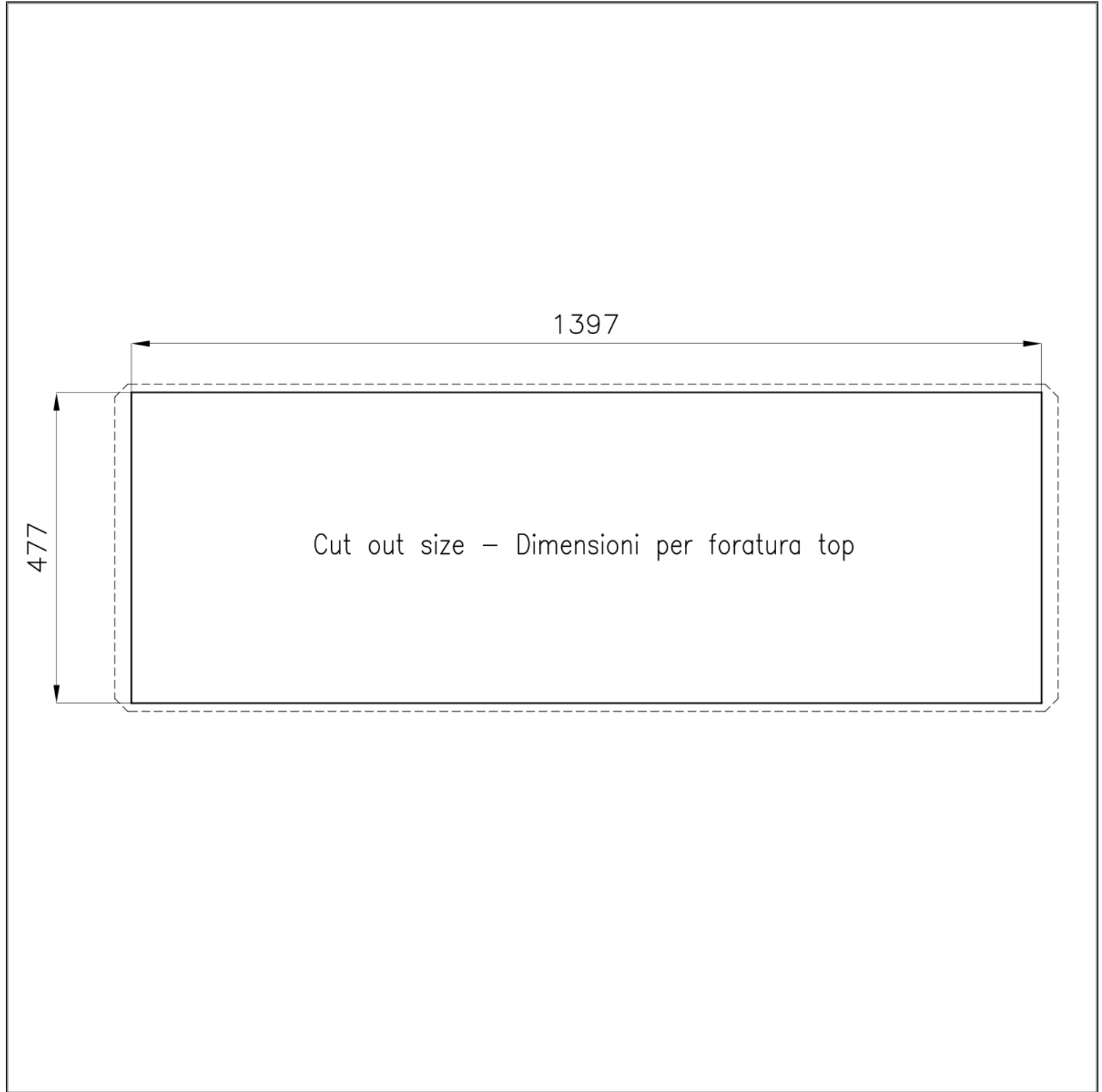

## GALLERY

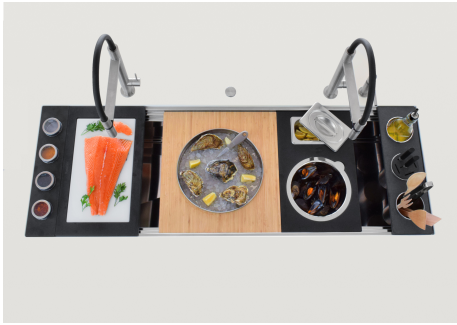
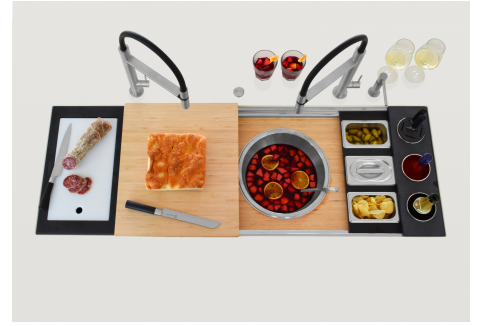

### Optional accessories

The "rails" system makes it possible to use a combination of numerous accessories. Grids, chopping boards, utensils, ranging systems, bowls and containers of different dimensions can be alternated in the workspace with a simple gesture, and can easily be stacked, in order to be on hand at all times.

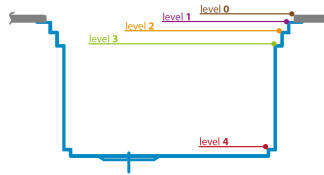

## EQUIPMENT



**GRILLE NOIRE POUR EVIERS RIVA**  
A100 E00

## OPTIONAL ACCESSORIES



**CUVETTE INOX PERFOREE**

A151 F00

\* only in combination with the accessory  
A644 A01



**CUVETTE PLASTIQUE BLANCHE**

A153 A00

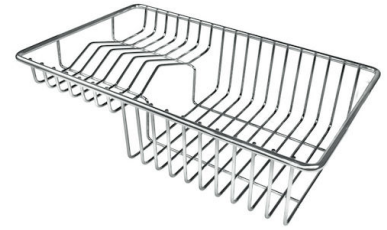

**GRILLE POR.ASSIETTES INOX  
mm214x379**

A100 C03

\* only in combination with the accessory  
A644 A01



**KIT CUBE RONDE ET CUVETTE  
RECTANGULAIRE POUR EVIERS  
CONVIVIO**

A100 E28



**KIT DEUX CUVETTES INOX POUR  
EVIERS CONVIVIO**

A100 E23



**KIT RÂPES ET PLANCHE DE  
DECOUPE HDPE**

A159 A01

\* only in combination with the accessory  
A644 A01



**KIT TROIS CUVETTES INOX POUR  
EVIERS CONVIVIO**

A100 E22



**KIT TROIS CUVETTES INOX POUR  
EVIERS CONVIVIO**

A100 E24



**PLANCHE BAMBOU AVEC CUBE  
INOX**

A200 E01



**PLANCHE DE DECOUPE BOIS POUR  
EVIERS RIVA**

A642 F00



**PLANCHE DE DECOUPE CRYSTAL  
23x41 CM**

A631 C00



**PLANCHE DE DECOUPE DOUBLE  
HDPE**

A644 A01



**PLANCHE DE DECOUPE HDPE  
POUR EVIERS CONVIVIO**  
A100 E27



**PLAT INOX POUR EVIERS CONVIVIO**  
A778 F00



**PORTE-BOUTEILLES POUR EVIERS  
CONVIVIO**  
A100 E21



**PORTE-BOUTEILLES POUR EVIERS  
CONVIVIO**  
A100 E26



**PORTE-EPICES POUR EVIERS  
CONVIVIO**  
A100 E20



**PORTE-EPICES POUR EVIERS  
CONVIVIO**  
A100 E25

## RECOMMENDED PAIRINGS

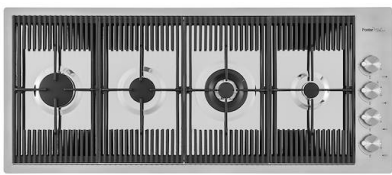

**MILANO 4 BRULEURS**  
G681 F00



**POLO**  
R525 A00

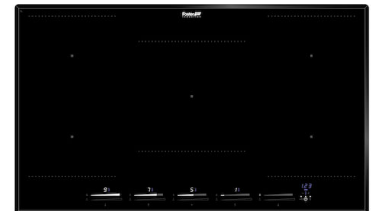

**PUNTO 860 INDUCTION 5 ZONES**  
I384 N45



**SAPONE SATINE**  
R520 A00



**VIDAGE FADE PUSH INOX**  
A407 A16